

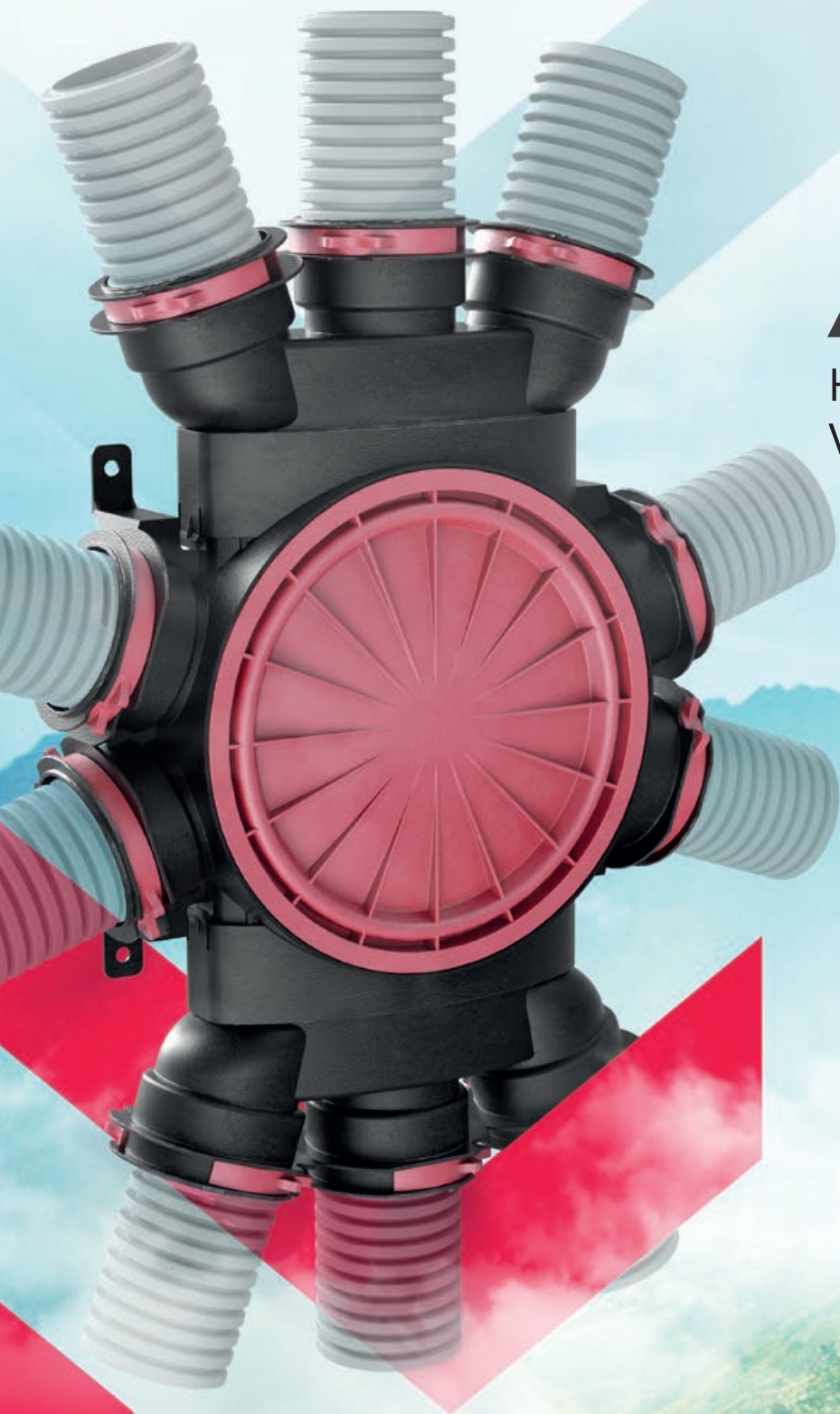

BETTER AIR WITH US



ARIA

HEAT RECOVERY
VENTILATION SYSTEM

TECHNICAL DATA



DISTRIBUTION BOX 10X75 HEATPEX ARIA



The HEATPEX ARIA distribution box is connected to the HRV unit. It is responsible for the supply of fresh air to or the extraction of dirty air from different rooms in a building.

- ⌚ A modular structure allows to customise the box to the air flow requirements.
- ⌚ 10 pipe sockets in the standard configuration
- ⌚ Designed to be used with the main or side central connector
- ⌚ Can be extended by connecting additional distribution boxes using the horizontal or vertical couplings

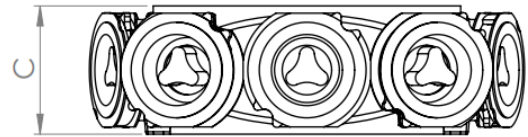
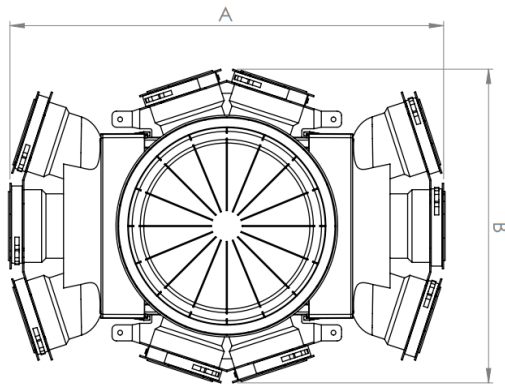

DIMENSION			SOCKETS	MATERIAL	MASS	CATALOGUE NO.
Length A	Width B	Height C	10	PP	1,47 kg	523 000 001
498 mm	360 mm	106 mm				



Pressure loss - Distribution box 10x75

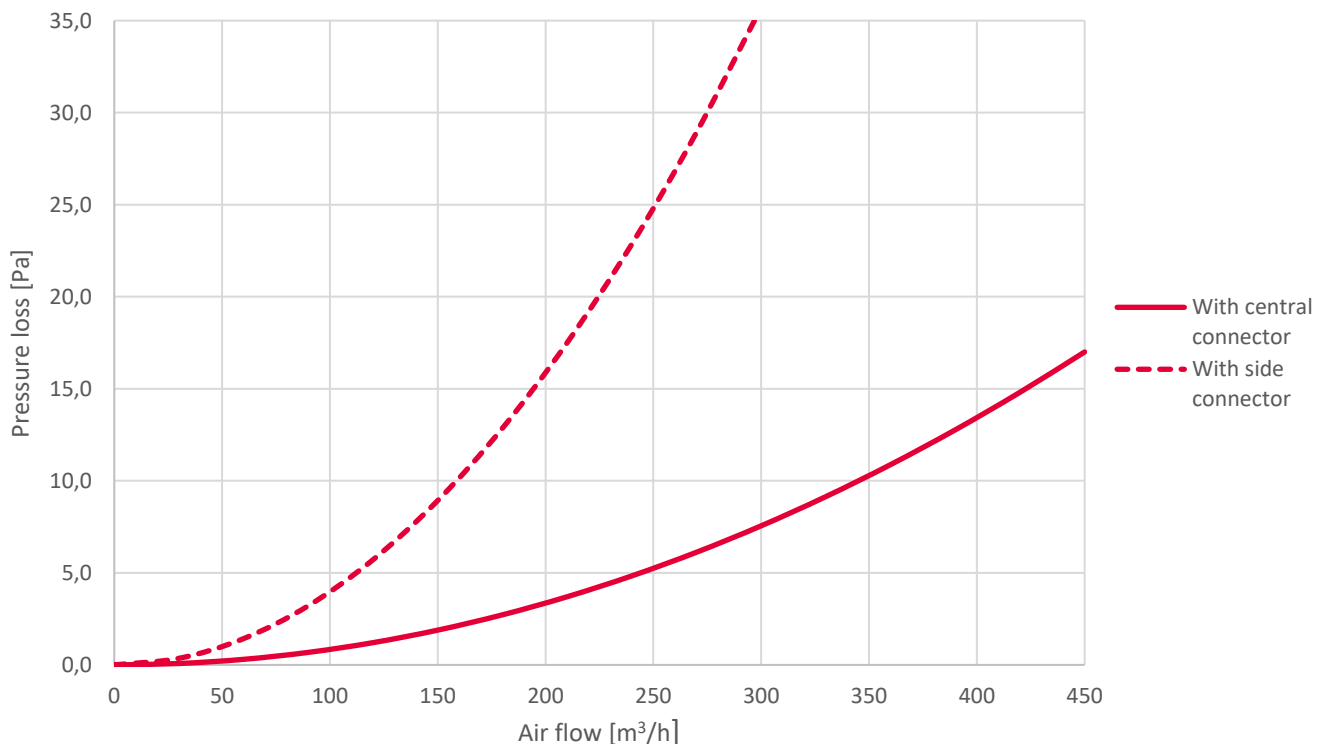



PLENUM BOX 3X75 HEATPEX ARIA



The plenum box allows to connect up to three 75 mm pipes to a 125 mm supply or exhaust air diffuser. Each unused connection must be covered with a 75 mm end plug (supplied by the manufacturer)

- ⦿ Installation on the main (structural) ceiling, or inside the plenum space if a dropped ceiling is used
- ⦿ Adjustable fixing wings
- ⦿ Ribbed surface to ease cutting the diffuser pipe

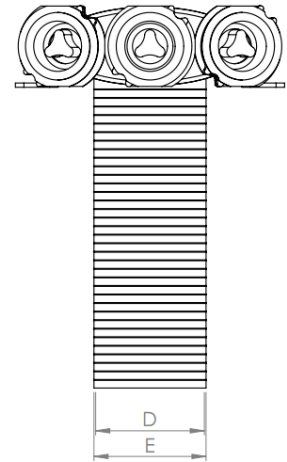
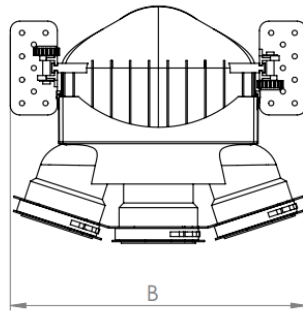
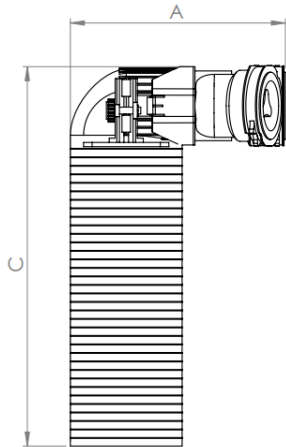

DIMENSIONS					SOCKETS	MATERIAL	MASS	CATALOGUE NO.
Length A	Width B	Height C	ID D	OD E	3	PP	0,754 kg	523 375 001
248 mm	315 mm	447 mm	124,1 mm	128 mm				



Pressue Loss - Plenum box 3x75 HEATPEX ARIA

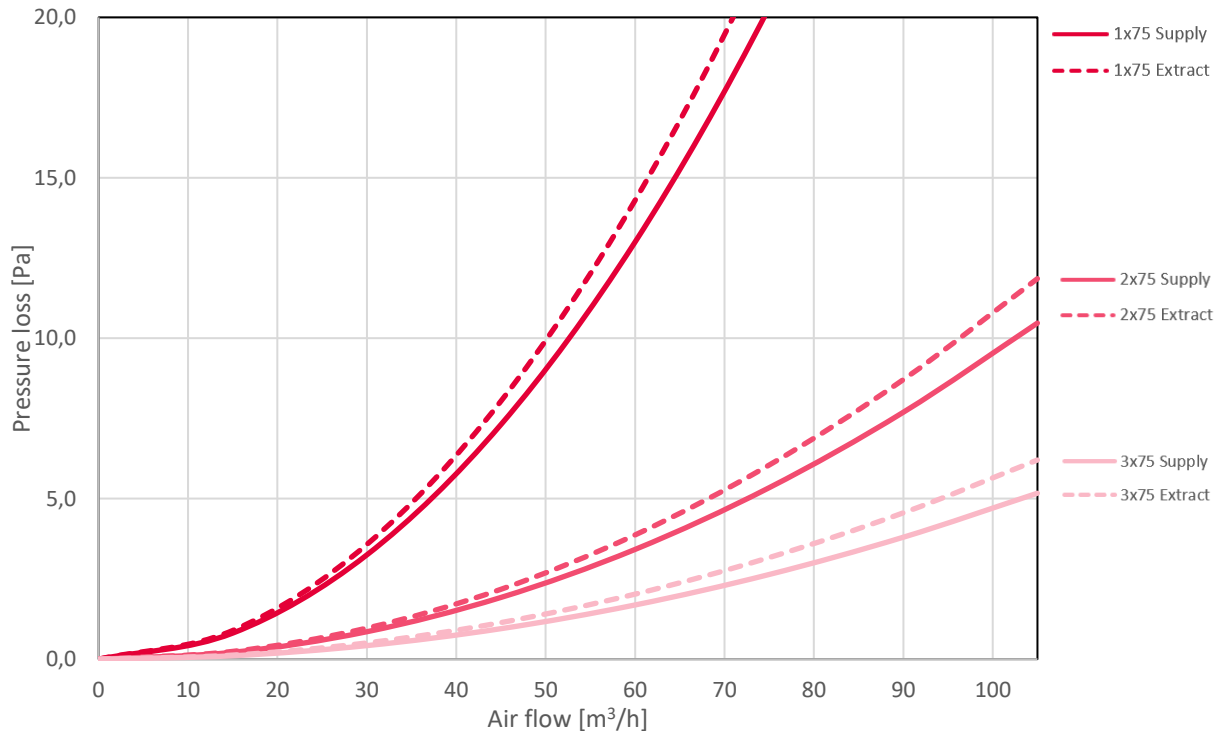



MAIN CENTRAL CONNECTOR HEATPEX ARIA



The main central connector is used to connect the main supply air pipe or the main exhaust air pipe to the distribution box. The unused part which diameter is smaller than that of the pipe should be cut off.

- ⤷ Installed in the main slot of the distribution box
- ⤷ Designed for connection of 125 mm, 160 mm and 200 mm pipes
- ⤷ Standard ventilation diameters allows to connect typical round ducts and fittings

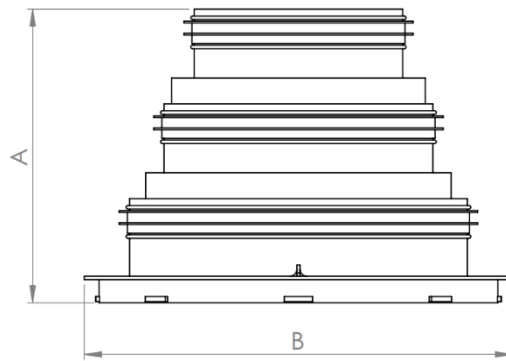

DIMENSIONS		STUB ENDS DIAMETERS	MATERIAL	MASS	CATALOGUE NO.
Height A	Diameter B	125/160/200 mm	PP	0,287	524 109 001
170,4 mm	249 mm				

*Pressure loss – check data for **Distribution box 10x75** HEATPEX ARIA



MAIN SIDE CONNECTOR 125/160 HEATPEX ARIA



The side connector is used to connect the main supply air or exhaust air pipe to either side of the distribution box. It is designed to be fixed into the oval slot on either side of the distribution box replacing one 3x75 module. If a 125 mm diameter pipe is used, the unused part should be cut off.

- ⌚ To be fixed into the oval slot on either side of the distribution box, in place of a 3x75 module
- ⌚ Designed for connection of 125 mm and 160 mm pipes
- ⌚ Standard ventilation diameters allows to connect typical round ducts and fittings

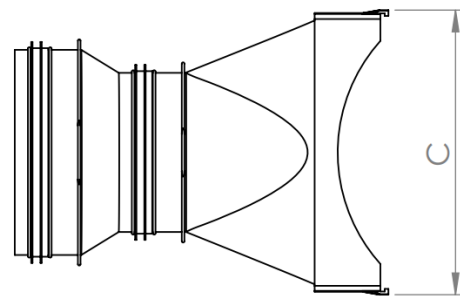
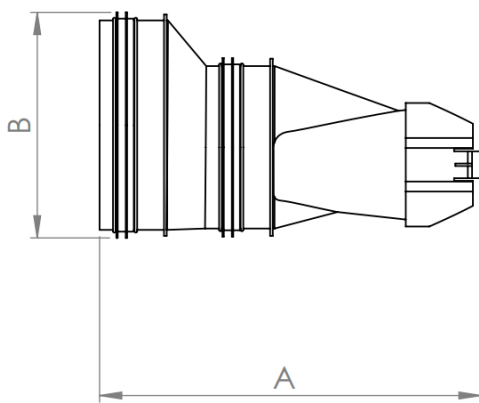

DIMENSIONS			STUB ENDS DIAMETERS	MATERIAL	MASS	CATALOGUE NO.
Length A	Width C	Height B	125/160 mm	PP	0,259 kg	524 110 001
284 mm	216 mm	167 mm				

*Pressure loss – check data for **Distribution Box 10X75** HEATPEX ARIA



HORIZONTAL COUPLING HEATPEX ARIA



The horizontal coupling is used to connect two or more distribution boxes horizontally.

- ⦿ To be fixed into the oval slot of the distribution box
- ⦿ Connecting additional distribution box increases the number of available sockets by four

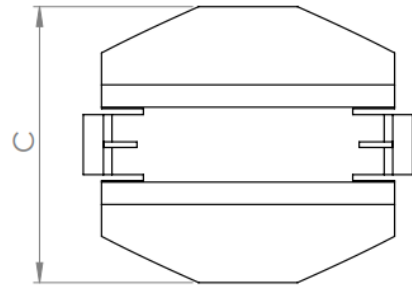
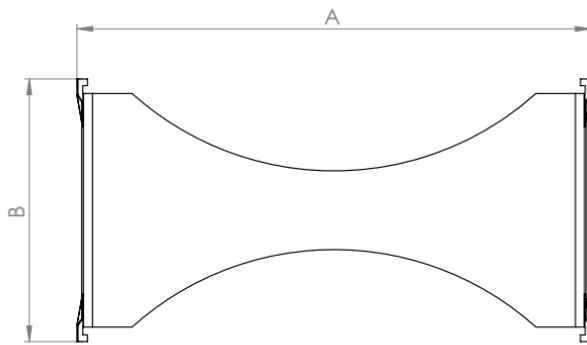

DIMENSIONS			MATERIAL	MASS	CATALOGUE NO.
Length A	Width B	Height C	PP	0,65 kg	524 111 001
216 mm	110 mm	92 mm			



VERTICAL COUPLING HEATPEX ARIA



Vertical coupling is used to connect two or more distribution boxes vertically.



- ⦿ To be fixed into the main slot of the distribution box
- ⦿ Connecting another distribution box vertically increases the number of available socket by ten
- ⦿ Indentation for fingers for easy installation of the connector in the distribution box

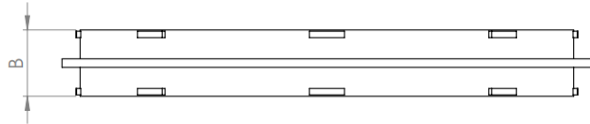
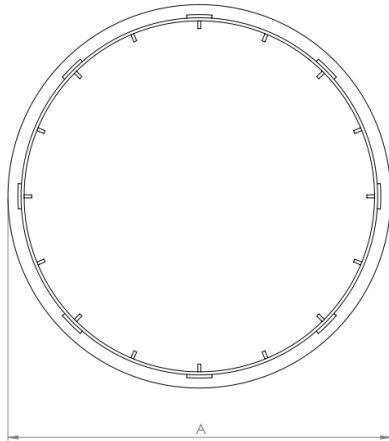

DIMENSIONS		MATERIAL	MASS	CATALOGUE NO.
Diameter A	Height B	PP	0,057 kg	524 112 001
249 mm	110 mm			



PIPE 75 HEATPEX ARIA

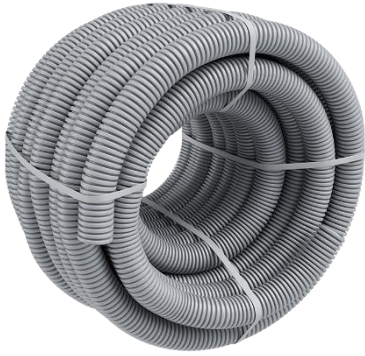

A flexible 75 mm pipe made of high-density polyethylene PE-HD.

- Antimicrobial inner Surface, with 99% reduction of bacteria
- Very high flexibility resulting in easy installation, with no pipe elbows needed
- Smooth inner surface reduces flow resistance to a minimum and makes cleaning easier
- Very good soundproofing thanks to double wall structure

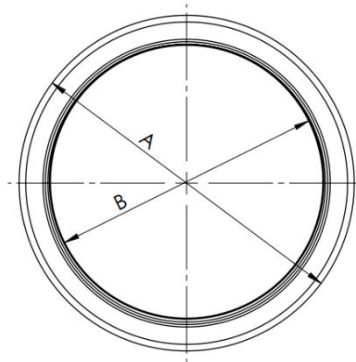
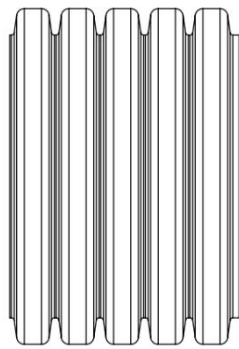

DIMENSIONS			MATERIAL	MASS	CATALOGUE NO.
Outer diameter A	Inner diameter B	Coil length	PE-HD	0,273 kg/m	520 075 050
76 mm	62,5 mm	50 m			



Pressure loss - Pipe 75 HEATPEX ARIA

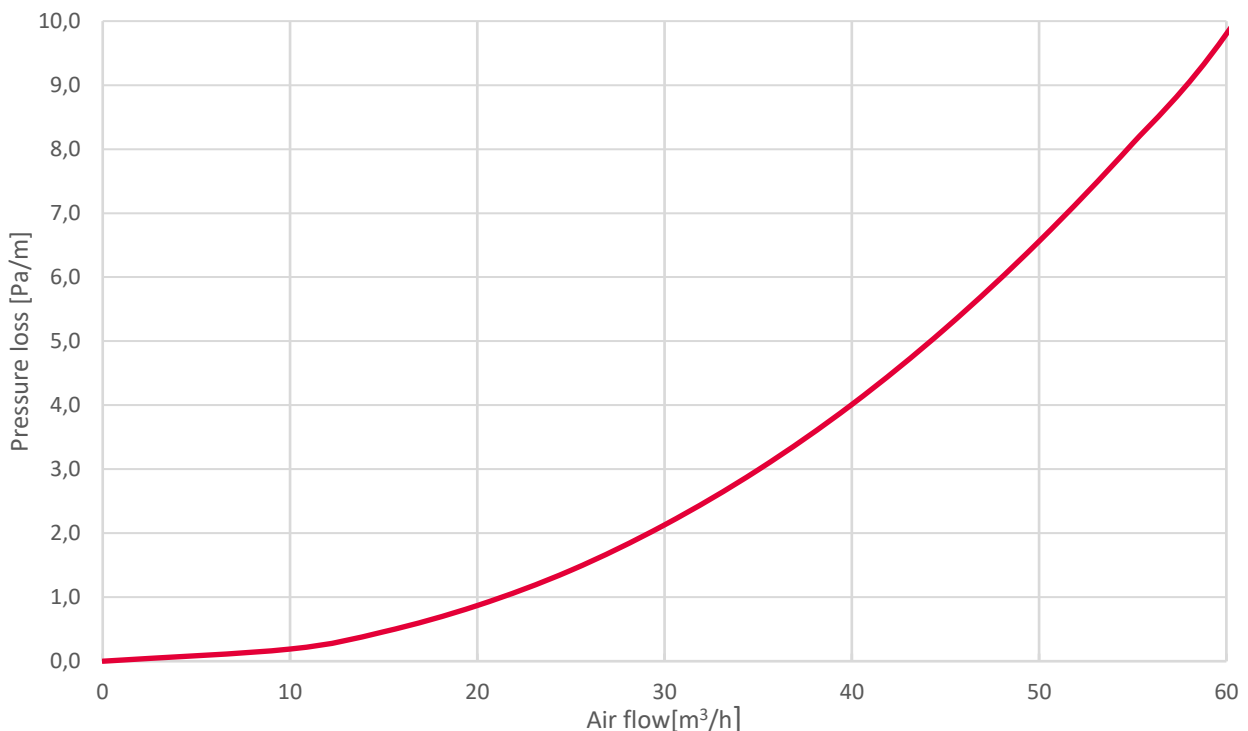



DAMPER 125 HEATPEX ARIA



Damper made of EVA foam . It helps to adjust the ventilation system and effectively reduces noise.

- ⊗ Effective noise reduction
- ⊗ Easy installation inside the plenum box
- ⊗ Stepless adjustment of the air flow rate by turning the damper disc

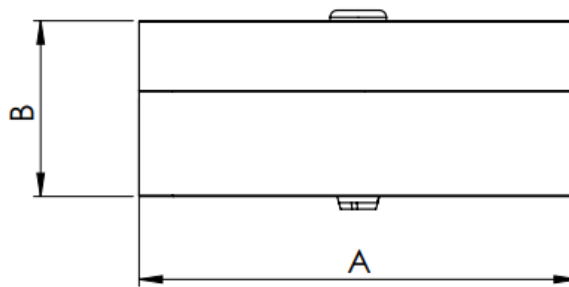

DIMENSIONS		MATERIAL	MASS	CATALOGUE NO.
Diameter A	Height B	EVA	0,05 kg	520 024 001
128 mm	50 mm			



DISTRIBUTION BOX END PLUG HEATPEX ARIA



End plug for distribution box allowing to install the box next to the wall. Useful when there is limited space available and the distribution box has to be placed directly by the wall. Installed in place of one 3×75 module.

- ⤷ Allows to install distribution box next to the wall
- ⤷ Installed in place of a 3x75 module

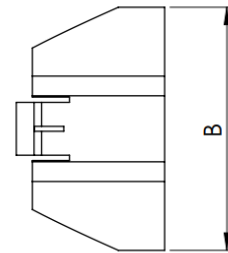
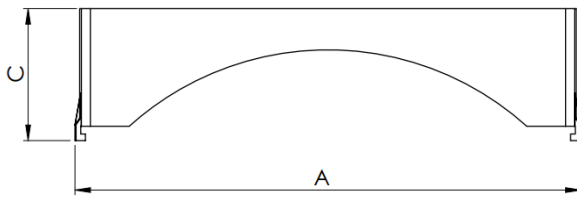

DIMENSIONS			MATERIAL	CATALOGUE NO.
Width A	Height B	Depth C	PP	520 011 001
216 mm	92 mm	55 mm		